

ASM3P2869A

Low Power Peak EMI Reducing Solution

Description

The ASM3P2869A is a versatile spread spectrum frequency modulator designed specifically for a wide range of clock frequencies. The ASM3P2869A reduces electromagnetic interference (EMI) at the clock source, allowing system wide reduction of EMI of all clock dependent signals. The ASM3P2869A allows significant system cost savings by reducing the number of circuit board layers, ferrite beads and shielding that are traditionally required to pass EMI regulations.

The ASM3P2869A uses the most efficient and optimized modulation profile approved by the FCC and is implemented by using a proprietary all digital method.

The ASM3P2869A modulates the output of a single PLL in order to “spread” the bandwidth of a synthesized clock, and more importantly, decreases the peak amplitudes of its harmonics. This results in significantly lower system EMI compared to the typical narrow band signal produced by oscillators and most frequency generators. Lowering EMI by increasing a signal’s bandwidth is called ‘spread spectrum clock generation.’

Applications

The ASM3P2869A is targeted towards all portable devices with very low power requirements like MP3 players, Notebooks and digital still cameras.

Features

- Generates an EMI Optimized Clock Signal at the Output
- Integrated Loop Filter Components
- Operates with a 3.3 V / 2.5 V Supply
- Operating Current less than 4 mA
- Low Power CMOS Design
- Input Frequency Range:
 - 6 MHz to 12 MHz for 2.5 V
 - 6 MHz to 13 MHz for 3.3 V
- Generates a 1X Low EMI Spread Spectrum Clock of the Input Frequency
- Frequency Deviation: $\pm 1\%$ (Typ) @ 10 MHz
- Available in 6-pin TSOT-23, 8-pin SOIC and 8-pin TSSOP Packages
- These Devices are Pb-Free, Halogen Free/BFR Free and are RoHS Compliant



ON Semiconductor®

<http://onsemi.com>



TSOT-6
O SUFFIX
CASE 419AF



TSSOP-8
T SUFFIX
CASE 948AL

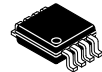

SOIC-8
S SUFFIX
CASE 751BD

PIN CONFIGURATIONS

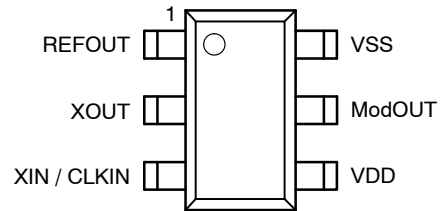

6-Pin TSOT-23 Package
(Top View)

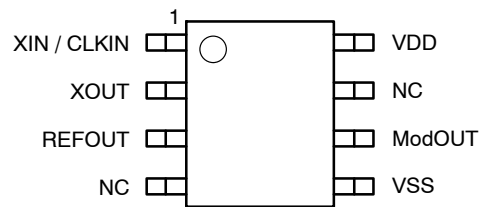

8-Pin SOIC and TSSOP Packages
(Top View)

KEY SPECIFICATIONS

Description	Specification
Supply Voltages	VDD = 2.5 V / 3.3 V
Cycle-to-Cycle Jitter	200 pS (Max)
Output Duty Cycle	45/55%
Modulation Rate Equation	$F_{IN}/256$
Frequency Deviation	$\pm 1\%$ (Typ) @ 10 MHz

ORDERING INFORMATION

See detailed ordering and shipping information in the package dimensions section on page 10 of this data sheet.

ASM3P2869A

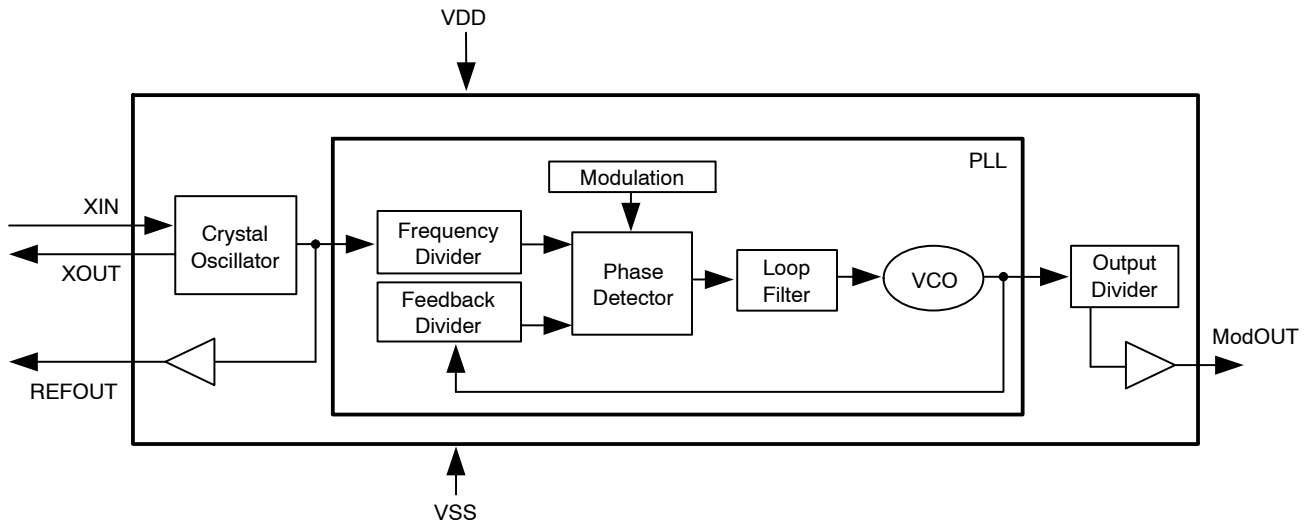

Figure 1. Block Diagram

Table 1. PIN DESCRIPTION (6-Pin TSOT-23 Package)

Pin#	Pin Name	Type	Description
1	REFOUT	O	Buffered output of the input frequency.
2	XOUT	O	Crystal connection. If using an external reference, this pin must be left unconnected.
3	XIN / CLKIN	I	Crystal connection or external reference frequency input. This pin has dual functions. It can be connected either to an external crystal or an external reference clock.
4	VDD	P	Power supply for the entire chip.
5	ModOUT	O	Spread spectrum clock output.
6	VSS	P	Ground connection.

Table 2. PIN DESCRIPTION (8-Pin SOIC and TSSOP Packages)

Pin#	Pin Name	Type	Description
1	XIN / CLKIN	I	Crystal connection or external reference frequency input. This pin has dual functions. It can be connected either to an external crystal or an external reference clock.
2	XOUT	O	Crystal connection. If using an external reference, this pin must be left unconnected.
3	REFOUT	O	Buffered output of the input frequency.
4	NC	-	No connect.
5	VSS	P	Ground connection.
6	ModOUT	O	Spread spectrum clock output.
7	NC	-	No connect.
8	VDD	P	Power supply for the entire chip.

ASM3P2869A

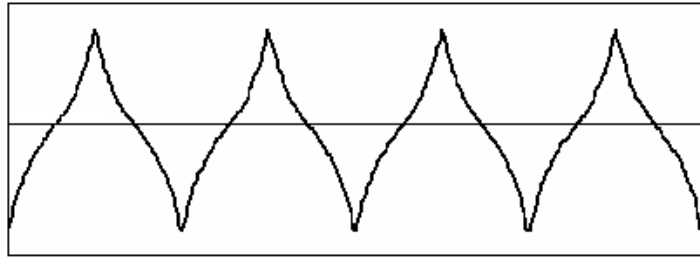

Figure 2. Modulation Profile

Table 3. SPECIFICATIONS

Description		Specification
Frequency Range	For 2.5 V Supply	6 MHz < CLKIN < 12 MHz
	For 3.3 V Supply	6 MHz < CLKIN < 13 MHz
Modulation Equation		$F_{IN}/256$
Frequency Deviation		$\pm 1\%$ (Typ) @ 10 MHz

Table 4. ABSOLUTE MAXIMUM RATINGS

Symbol	Parameter	Rating	Unit
VDD, VIN	Voltage on any pin with respect to Ground	-0.5 to +4.6	V
T _{STG}	Storage temperature	-65 to +125	°C
T _A	Operating temperature	-40 to +85	°C
T _s	Max. Soldering Temperature (10 sec)	260	°C
T _J	Junction Temperature	150	°C
T _{DV}	Static Discharge Voltage (As per JEDEC STD22- A114-B)	2	KV

Stresses exceeding Maximum Ratings may damage the device. Maximum Ratings are stress ratings only. Functional operation above the Recommended Operating Conditions is not implied. Extended exposure to stresses above the Recommended Operating Conditions may affect device reliability.

ASM3P2869A

Table 5. DC ELECTRICAL CHARACTERISTICS FOR 2.5 V SUPPLY

(Test condition: All parameters are measured at room temperature (+25°C) unless otherwise stated.)

Symbol	Parameter	Min	Typ	Max	Unit
V _{IL}	Input low voltage	VSS-0.3	-	0.8	V
V _{IH}	Input high voltage	2.0	-	VDD+0.3	V
I _{IL}	Input low current	-	-	-35	μA
I _{IH}	Input high current	-	-	35	μA
I _{XOL}	XOUT output low current (@ 0.5 V, VDD = 2.5 V)	-	3	-	mA
I _{XOH}	XOUT output high current (@ 1.8 V, VDD = 2.5 V)	-	3	-	mA
V _{OL}	Output low voltage (VDD = 2.5 V, I _{OL} = 8 mA)	-	-	0.6	V
V _{OH}	Output high voltage (VDD = 2.5 V, I _{OH} = 8 mA)	1.8	-	-	V
I _{DD}	Static supply current (Note 1)	-	1.0	-	mA
I _{CC}	Dynamic supply current (2.5 V, 10 MHz and no load)	-	3.0	-	mA
VDD	Operating voltage	2.375	2.5	2.625	V
t _{ON}	Power-up time (first locked cycle after power-up)	-	-	5	mS
Z _{OUT}	Output impedance	-	50	-	Ω

1. XIN / CLKIN pin is pulled low.

Table 6. AC ELECTRICAL CHARACTERISTICS FOR 2.5 V SUPPLY

Symbol	Parameter	Min	Typ	Max	Unit	
CLKIN	Input frequency	6	-	12	MHz	
ModOUT	Output frequency	6	-	12	MHz	
f _d	Frequency Deviation	Input Frequency = 6 MHz	-	±1.6	-	%
		Input Frequency = 12 MHz	-	±0.8	-	
t _{LH} (Note 2)	Output rise time (measured from 0.7 V to 1.7 V)	-	1.5	1.7	nS	
t _{HL} (Note 2)	Output fall time (measured from 1.7 V to 0.7 V)	0.5	1.0	1.2	nS	
t _{JC}	Jitter (Cycle-to-Cycle)	-	-	200	pS	
t _D	Output duty cycle	45	50	55	%	

2. t_{LH} and t_{HL} are measured into a capacitive load of 15 pF.

ASM3P2869A

Table 7. DC ELECTRICAL CHARACTERISTICS FOR 3.3 V SUPPLY

(Test condition: All parameters are measured at room temperature (+25°C) unless otherwise stated.)

Symbol	Parameter	Min	Typ	Max	Unit
V _{IL}	Input low voltage	VSS-0.3	-	0.8	V
V _{IH}	Input high voltage	2.0	-	VDD+0.3	V
I _{IL}	Input low current	-	-	-35	μA
I _{IH}	Input high current	-	-	35	μA
I _{XOL}	XOUT output low current (@ 0.4 V, VDD = 3.3 V)	-	3	-	mA
I _{XOH}	XOUT output high current (@ 2.5 V, VDD = 3.3 V)	-	3	-	mA
V _{OL}	Output low voltage (VDD = 3.3 V, I _{OL} = 8 mA)	-	-	0.4	V
V _{OH}	Output high voltage (VDD = 3.3 V, I _{OH} = 8 mA)	2.5	-	-	V
I _{DD}	Static supply current (Note 3)	-	1.3	-	mA
I _{CC}	Dynamic supply current (3.3 V, 10 MHz and no load)	-	4.0	-	mA
VDD	Operating Voltage	2.7	3.3	3.6	V
t _{ON}	Power-up time (first locked cycle after power-up)	-	-	5	mS
Z _{OUT}	Output impedance	-	45	-	Ω

3. XIN / CLKIN pin is pulled low.

Table 8. AC ELECTRICAL CHARACTERISTICS FOR 3.3 V SUPPLY

Symbol	Parameter	Min	Typ	Max	Unit	
CLKIN	Input frequency	6	-	13	MHz	
ModOUT	Output frequency	6	-	13	MHz	
f _d	Frequency Deviation	Input Frequency = 6 MHz	-	±1.6	-	%
		Input Frequency = 13 MHz	-	±0.65	-	
t _{LH} (Note 4)	Output rise time (measured from 0.8 V to 2.0 V)	0.5	1.4	1.6	nS	
t _{HL} (Note 4)	Output fall time (measured at 2.0 V to 0.8 V)	0.4	1.0	1.2	nS	
t _{JC}	Jitter (Cycle-to-Cycle)	-	-	200	pS	
t _D	Output duty cycle	45	50	55	%	

4. t_{LH} and t_{HL} are measured into a capacitive load of 15 pF.

ASM3P2869A

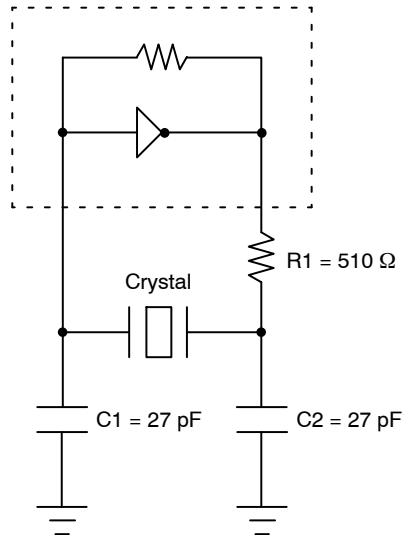

Figure 3. Typical Crystal Oscillator Circuit

Table 9. TYPICAL CRYSTAL SPECIFICATIONS

Fundamental AT Cut Parallel Resonant Crystal	
Nominal frequency	8.000 MHz
Frequency tolerance	±50 ppm or better at 25°C
Operating temperature range	-25°C to +85°C
Storage temperature	-40°C to +85°C
Load capacitance	18 pF
Shunt capacitance	7 pF maximum
ESR	25 Ω

ASM3P2869A

PACKAGE DIMENSIONS

TSOT-23, 6 LEAD
CASE 419AF-01
ISSUE O

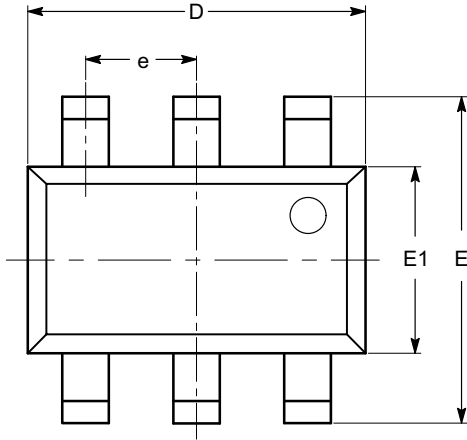

TOP VIEW

SYMBOL	MIN	NOM	MAX
A			1.00
A1	0.01	0.05	0.10
A2	0.80	0.87	0.90
b	0.30		0.45
c	0.12	0.15	0.20
D	2.90 BSC		
E	2.80 BSC		
E1	1.60 BSC		
e	0.95 TYP		
L	0.30	0.40	0.50
L1	0.60 REF		
L2	0.25 BSC		
θ	0°		8°

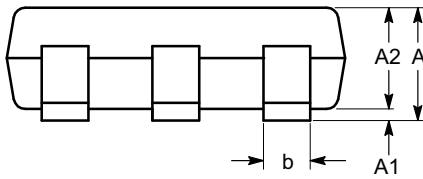

SIDE VIEW

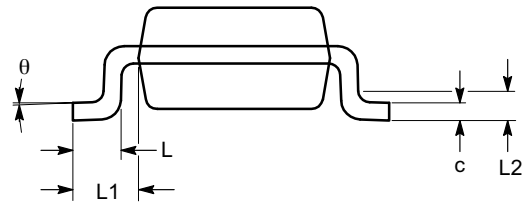

END VIEW

Notes:

- (1) All dimensions are in millimeters. Angles in degrees.
- (2) Complies with JEDEC MO-193.

ASM3P2869A

PACKAGE DIMENSIONS

SOIC 8, 150 mils
CASE 751BD-01
ISSUE O

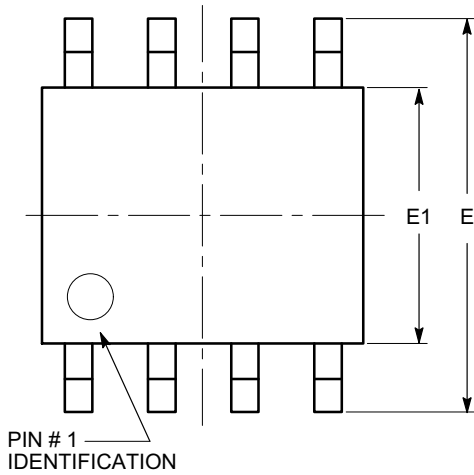

TOP VIEW

SYMBOL	MIN	NOM	MAX
A	1.35		1.75
A1	0.10		0.25
b	0.33		0.51
c	0.19		0.25
D	4.80		5.00
E	5.80		6.20
E1	3.80		4.00
e	1.27 BSC		
h	0.25		0.50
L	0.40		1.27
θ	0°		8°

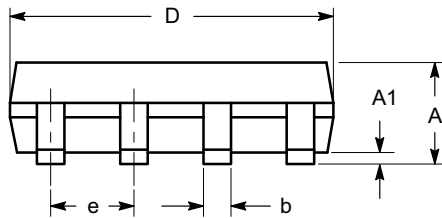

SIDE VIEW

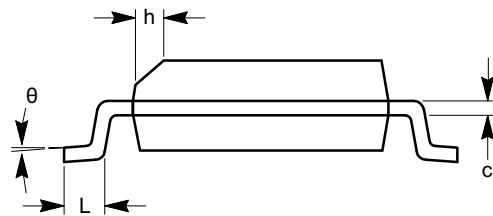

END VIEW

Notes:

- (1) All dimensions are in millimeters. Angles in degrees.
- (2) Complies with JEDEC MS-012.

ASM3P2869A

PACKAGE DIMENSIONS

TSSOP8, 4.4x3
CASE 948AL-01
ISSUE O

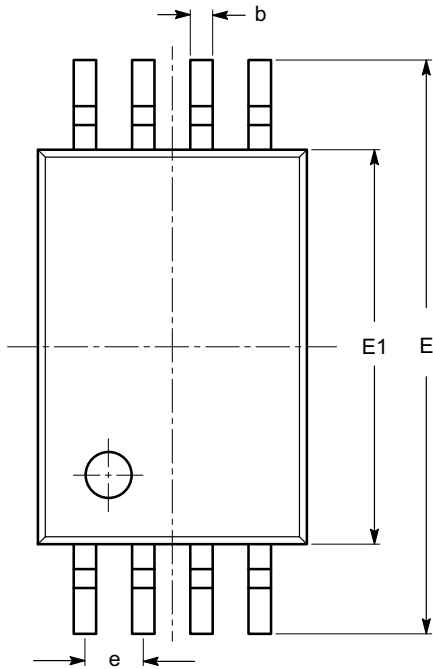

SYMBOL	MIN	NOM	MAX
A			1.20
A1	0.05		0.15
A2	0.80	0.90	1.05
b	0.19		0.30
c	0.09		0.20
D	2.90	3.00	3.10
E	6.30	6.40	6.50
E1	4.30	4.40	4.50
e	0.65 BSC		
L	1.00 REF		
L1	0.50	0.60	0.75
θ	0°		8°

TOP VIEW

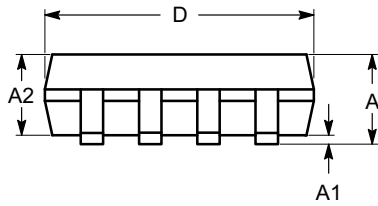

SIDE VIEW

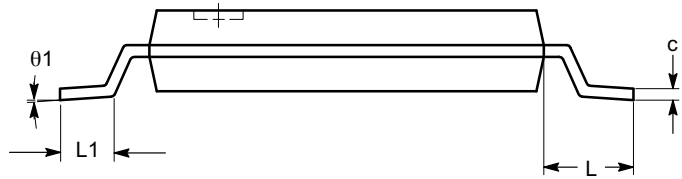

END VIEW

Notes:

- (1) All dimensions are in millimeters. Angles in degrees.
- (2) Complies with JEDEC MO-153.

ASM3P2869A

Table 10. ORDERING INFORMATION

Part Number	Marking	Package Type	Temperature
ASM3P2869AF-06OR	K4LL	6-Pin TSOT-23, TAPE & REEL, Pb Free	Commercial
ASM3P2869AF-08TT	3P2869AF	8-Pin TSSOP, TUBE, Pb Free	Commercial
ASM3P2869AF-08TR	3P2869AF	8-Pin TSSOP, TAPE & REEL, Pb Free	Commercial
ASM3P2869AF-08ST	3P2869AF	8-Pin SOIC, TUBE, Pb Free	Commercial
ASM3P2869AF-08SR	3P2869AF	8-Pin SOIC, TAPE & REEL, Pb Free	Commercial
ASM3P2869AG-06OR	K3LL	6-Pin TSOT-23, TAPE & REEL, Green	Commercial
ASM3P2869AG-08TT	3P2869AG	8-Pin TSSOP, TUBE, Green	Commercial
ASM3P2869AG-08TR	3P2869AG	8-Pin TSSOP, TAPE & REEL, Green	Commercial
ASM3P2869AG-08ST	3P2869AG	8-Pin SOIC, TUBE, Green	Commercial
ASM3P2869AG-08SR	3P2869AG	8-Pin SOIC, TAPE & REEL, Green	Commercial
ASM3I2869AF-06OR	K5LL	6-Pin TSOT-23, TAPE & REEL, Pb Free	Industrial
ASM3I2869AF-08TT	3I2869AF	8-Pin TSSOP, TUBE, Pb Free	Industrial
ASM3I2869AF-08TR	3I2869AF	8-Pin TSSOP, TAPE & REEL, Pb Free	Industrial
ASM3I2869AF-08ST	3I2869AF	8-Pin SOIC, TUBE, Pb Free	Industrial
ASM3I2869AF-08SR	3I2869AF	8-Pin SOIC, TAPE & REEL, Pb Free	Industrial
ASM3I2869AG-06OR	K6LL	6-Pin TSOT-23, TAPE & REEL, Green	Industrial
ASM3I2869AG-08TT	3I2869AG	8-Pin TSSOP, TUBE, Green	Industrial
ASM3I2869AG-08TR	3I2869AG	8-Pin TSSOP, TAPE & REEL, Green	Industrial
ASM3I2869AG-08ST	3I2869AG	8-Pin SOIC, TUBE, Green	Industrial
ASM3I2869AG-08SR	3I2869AG	8-Pin SOIC, TAPE & REEL, Green	Industrial

ON Semiconductor and  are registered trademarks of Semiconductor Components Industries, LLC (SCILLC). SCILLC reserves the right to make changes without further notice to any products herein. SCILLC makes no warranty, representation or guarantee regarding the suitability of its products for any particular purpose, nor does SCILLC assume any liability arising out of the application or use of any product or circuit, and specifically disclaims any and all liability, including without limitation special, consequential or incidental damages. "Typical" parameters which may be provided in SCILLC data sheets and/or specifications can and do vary in different applications and actual performance may vary over time. All operating parameters, including "Typicals" must be validated for each customer application by customer's technical experts. SCILLC does not convey any license under its patent rights nor the rights of others. SCILLC products are not designed, intended, or authorized for use as components in systems intended for surgical implant into the body, or other applications intended to support or sustain life, or for any other application in which the failure of the SCILLC product could create a situation where personal injury or death may occur. Should Buyer purchase or use SCILLC products for any such unintended or unauthorized application, Buyer shall indemnify and hold SCILLC and its officers, employees, subsidiaries, affiliates, and distributors harmless against all claims, costs, damages, and expenses, and reasonable attorney fees arising out of, directly or indirectly, any claim of personal injury or death associated with such unintended or unauthorized use, even if such claim alleges that SCILLC was negligent regarding the design or manufacture of the part. SCILLC is an Equal Opportunity/Affirmative Action Employer. This literature is subject to all applicable copyright laws and is not for resale in any manner.

PUBLICATION ORDERING INFORMATION

LITERATURE FULFILLMENT:
 Literature Distribution Center for ON Semiconductor
 P.O. Box 5163, Denver, Colorado 80217 USA
Phone: 303-675-2175 or 800-344-3860 Toll Free USA/Canada
Fax: 303-675-2176 or 800-344-3867 Toll Free USA/Canada
Email: orderlit@onsemi.com

N. American Technical Support: 800-282-9855 Toll Free
 USA/Canada
Europe, Middle East and Africa Technical Support:
 Phone: 421 33 790 2910
Japan Customer Focus Center
 Phone: 81-3-5773-3850

ON Semiconductor Website: www.onsemi.com

Order Literature: <http://www.onsemi.com/orderlit>

For additional information, please contact your local Sales Representative